

Installation of receiving devices should be carried out by a qualified electrician. Any device with the signs of damage and/or missing parts should NOT be installed and should be returned to the seller. Before attempting installation, ensure all associated circuits and cables have been isolated at the source. Please refer to 'Installation Guidance Notes' supplied before commencing with the installation.

Devices are designed to be mounted internally only.

1 RFDEL-71B - 160W Single Channel Dimming Receiver With Switch Input

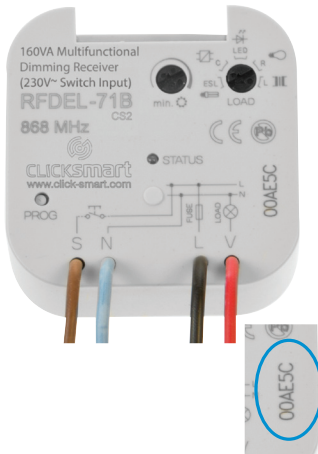

Select load type: Fluorescent, Capacitive, LED, Resistive or Inductive (For dimming dimmable LED's select LED or Capacitive load for best dimming compatibility).

The receiver will dim up to 160W of dimmable LED load. This can be variable on the type of dimmable LED driver.

The 'TRIM' facility allows the bottom end of dimming to be set so the lights can be seen to be on.

Receivers can be mounted directly behind individual appliances, control circuits locally or within the consumer unit. We recommend the receiver is installed inside a non-metallic enclosure.

The programme button is set back in to the housing. A thin blunt implement e.g. stylus can be used to press and hold the programming button.

We recommend noting the hexadecimal code printed on each receiver and the appliance it is controlling for potential future use.

The receiver can be controlled by up to 25 transmitting devices (including the wired input).

CS2 Memory: The product marked CS2 enables the receiver to remember the status (if engaged) in the event of a power cut. Once engaged and the current status has been running for longer than 15 seconds the current status will be stored. See 'Step 4' overleaf.

2 Signal Range

The RFDEL-71B has a signal range in free air of up to 160 metres.

Once the signal penetrates building materials etc., the signal range will be reduced. See the installation guidance notes supplied with this device.

3 Load Type

Load Types	R	L	C	ESL	LED
Maximum Load	160W	160W	160W	160W	160W*
Light Source	Leading Edge Incandescent & halogen	12-24V Wound Transformers	Trailing Edge 12-24V Electronic Transformers	Dimmable Fluorescent CFLi	Category 1 & 2 Regulation of the 230V~ input voltage. e.g. GU10, E27 & E14

* The load may change dependant on lamp or fitting manufacturer.

! Warning Inductive and resistive loads MUST NOT be connected together through one channel

4 Wiring

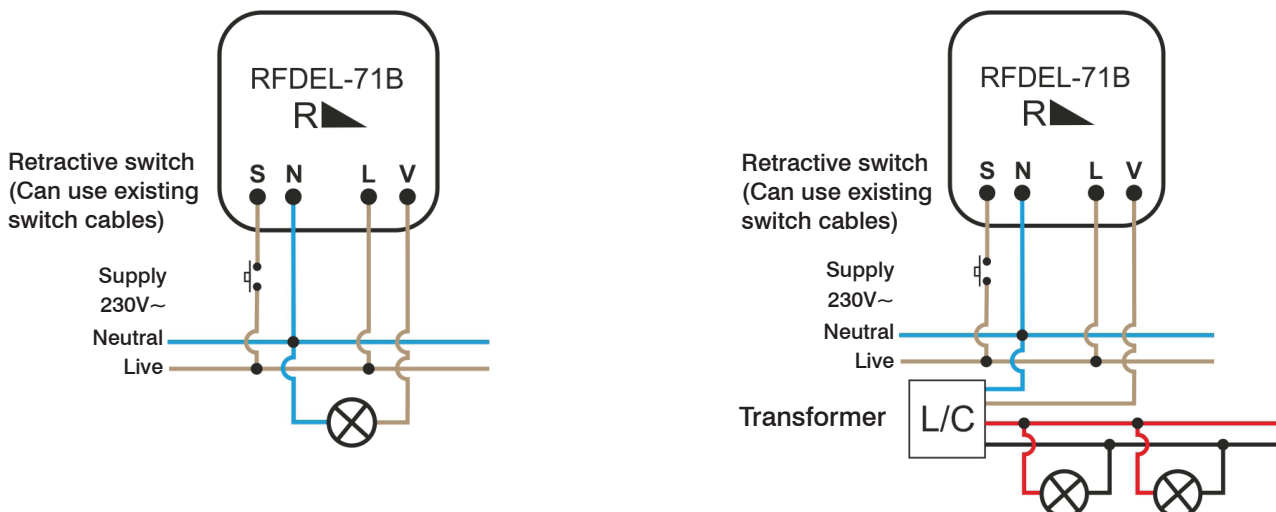

The 230V~ wired switch input (S) offers the facility to utilise existing switch cables with a retractable switch.

Not suitable for standard switches.

The wired retractive switch is pre-programmed to dimmable function 1 and cannot be changed (see functions overleaf).

If the switch input 'S' is not used, it must be isolated and NOT connected to the permanent live.

5 Functions (Dimming Receivers)

		Press button and release	Press button and hold
Function 1	Scene recall / OFF	Press to recall scene, press to turn OFF	Press button for more than 1 second to set scene brightness
Function 2	Scene recall / OFF - Anti-tamper	Press to recall scene, press again to turn OFF	Press button for more than 3 seconds to set scene brightness (avoids accidental scene setting)
Function 3	Scene recall - fade ON / fade OFF - Push to recall scene	Press to recall scene	Press button for more than 1 second to set scene brightness
Function 4	Scene recall / fade OFF	Press to recall scene	Press button for more than 1 second to set scene brightness
Function 5	Variable fade up to Max. (Definable 2 seconds to 30 mins)	Press to start fade up time to maximum brightness	N/A
Function 6	Variable fade down to OFF. (Definable 2 seconds to 30 mins)	Press to start fade down to OFF	N/A
Function 7	ON/OFF	Press once for ON, press again for OFF	N/A

Functions 5 & 6 (timed elements) are programmed in real time. If you require 30 minutes you have to wait for the 30 minutes to complete the pairing. To help save time and remove potential frustration on 5+ minute timed elements, we always recommend conducting a few shorter timed elements (e.g. 10 seconds) to ensure both the correct function and the correct timed element are programmed.

6 Programming The Receiver To Button Transmitters

When installing with the RF Pilot or RF Touch, use the dedicated product manuals for programming. The hardwired retractive switch input is pre-programmed to Function 1 and cannot be changed

STEP 1 - Programming Mode

Press & hold the 'programming' button on the receiver for 2 seconds (*the status LED will flash with a 1 second interval*).

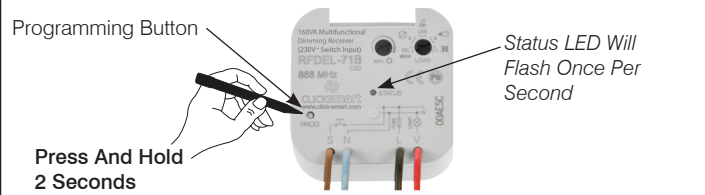

The programme button is recessed in to the body, this is standard. A small implement e.g. stylus can be used to press and hold the button.

STEP 2 - Select Function

To assign the required transmitter button & function, press the required button the number of times to match the function number (e.g function 2, press the button 2 times).

Press the transmitter button at one second intervals - See table of functions above.

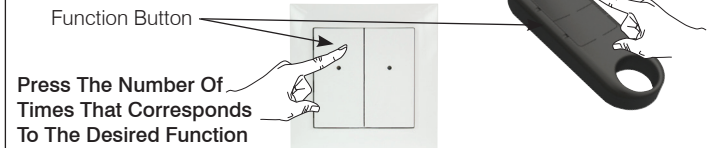

Each time the transmitter button is pressed the LED on the receiver will also flash to confirm the signal has been received.

STEP 3 - Only Required For Functions 5 & 6 (Time Elements) For All Other Functions Go To STEP 4

To set the time element, whilst still in programming mode, press & hold the 'programming' button again for '5 seconds' (the status LED will flash twice a second). **THE TIMER HAS NOW STARTED.**

When the required time period has elapsed, to stop the timer press the assigned transmitter button (IN STEP 2) once.

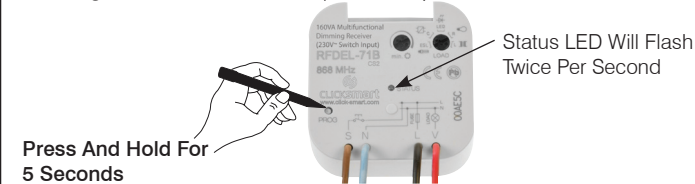

STEP 4 - Save & Exit

To exit programming mode press the 'programming' button for less than 1 second.



CS2 - Memory Status

Single LED flash on exit - Memory status not engaged

Double LED flash on exit - Memory status is engaged

To toggle between status's enter and exit programming mode.

To Remove A Single Transmitter Button From The Receiver

STAGE 1

Press And Hold For 5 Seconds

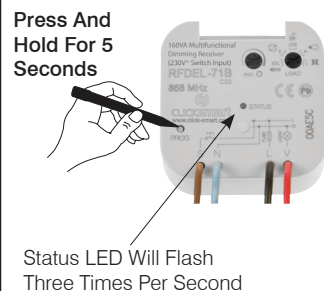

STAGE 2

Transmitter Button

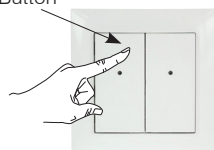

Press The Transmitter Button Once To Remove. The Receiver LED Status Should Be Off

To Remove All Paired Buttons

Press And Hold The 'Programming' Button For Longer Than 8 Seconds.

The LED status will change over the 8 seconds.

After 2 seconds the LED will flash once per second. After 5 seconds the LED will flash three times per second and after 8 seconds will go back to flashing once per second, release the programming button.

Press the programme button for less than 1 second to exit programming mode and remove all paired buttons.

